

HILTI

TE 7-A

Operating instructions

en

Mode d'emploi

fr

Manual de instrucciones

es

Manual de instruções

pt



1

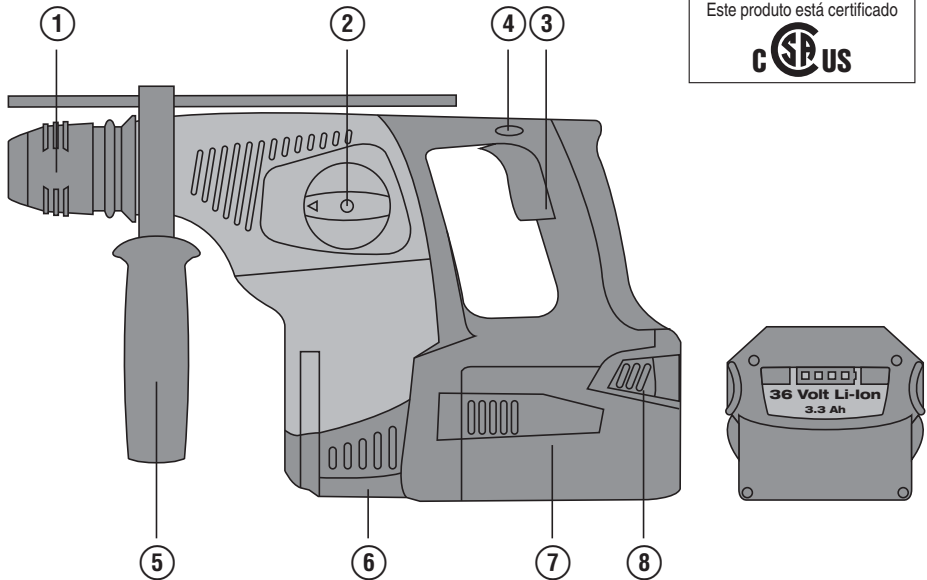
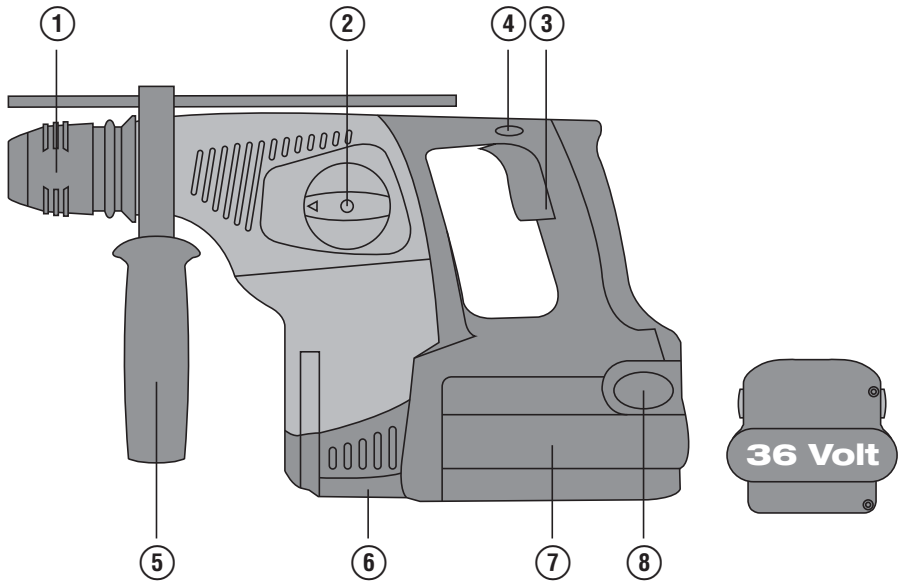

This Product is Certified
Ce produit est certifié
Este producto esta certificado
Este produto está certificado



2

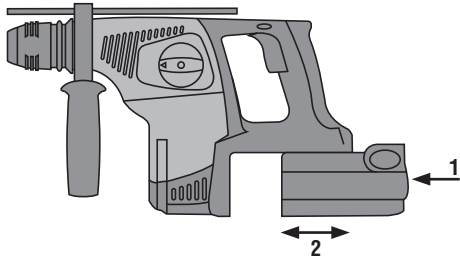

3

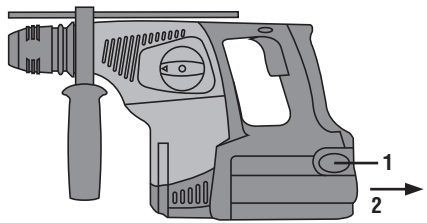

4

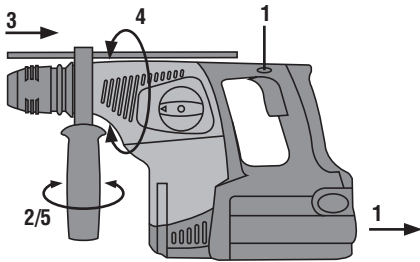

5

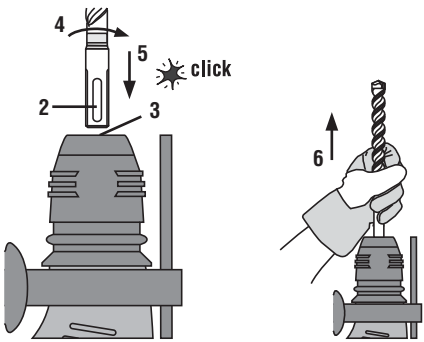
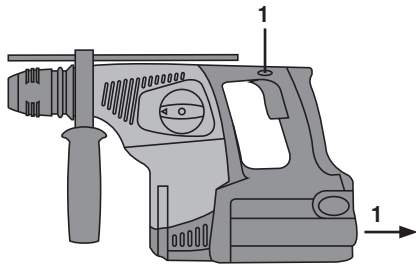

6

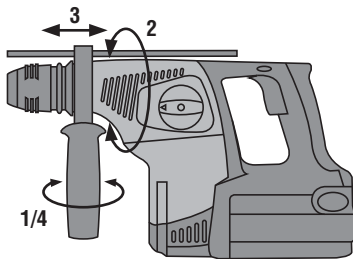

7

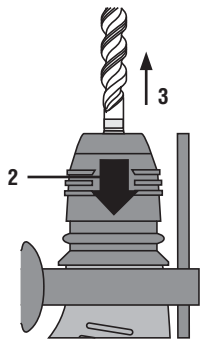
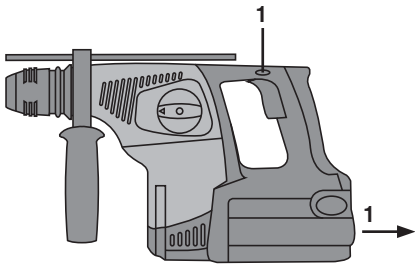

8

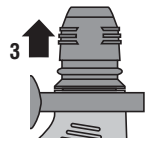
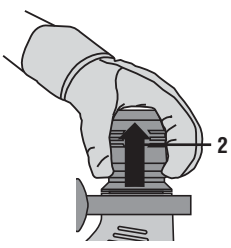
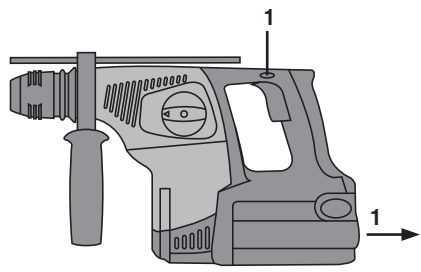

9

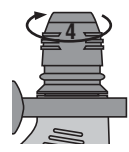
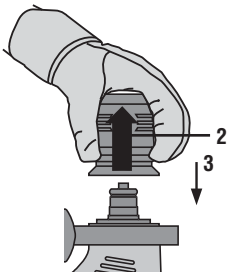
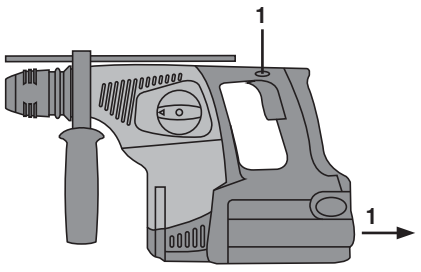

10

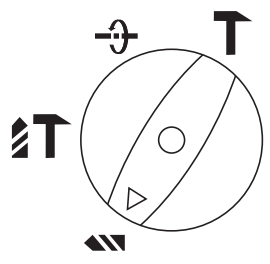

11

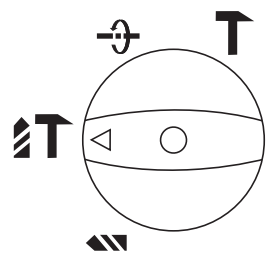

12

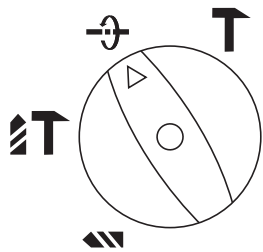

13

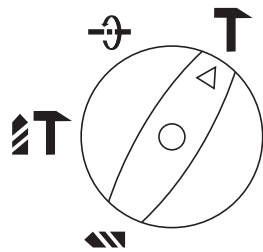

14

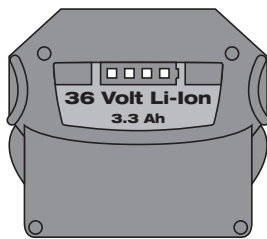
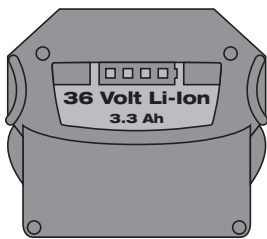

ORIGINAL OPERATING INSTRUCTIONS

TE 7-A cordless rotary hammer

It is essential that the operating instructions are read before the power tool is operated for the first time.

Always keep these operating instructions together with the power tool.

Ensure that the operating instructions are with the power tool when it is given to other persons.

Contents	Page
1 General information	1
2 Description	2
3 Insert tools, accessories	4
4 Technical data	4
5 Safety instructions	5
6 Before use	7
7 Operation	8
8 Care and maintenance	10
9 Troubleshooting	11
10 Disposal	12
11 Manufacturer's warranty - tools	13

1 These numbers refer to the corresponding illustrations. The illustrations can be found on the fold-out cover pages. Keep these pages open while studying the operating instructions.

In these operating instructions, the designation "the power tool" always refers to the TE 7-A cordless rotary hammer.

Operating controls and parts **1**

- 1 Chuck
- 2 Function selector switch
- 3 Control switch
- 4 Forward / reverse switch
- 5 Side handle with depth gauge
- 6 Interface for TE DRS-M dust removal module
- 7 Battery
- 8 Release buttons

en

1 General information

1.1 Safety notices and their meaning

DANGER

Draws attention to imminent danger that will lead to serious bodily injury or fatality.

WARNING

Draws attention to a potentially dangerous situation that could lead to serious personal injury or fatality.

CAUTION

Draws attention to a potentially dangerous situation that could lead to slight personal injury or damage to the equipment or other property.

NOTE

Draws attention to an instruction or other useful information.

1.2 Explanation of the pictograms and other information

Warning signs



General warning



Warning: electricity



Warning: caustic substances

Obligation signs



Wear eye protection



Wear a hard hat



Wear ear protection



Wear protective gloves



Wear breathing protection

Symbols



Read the operating instructions before use



Return waste material for recycling.



Drilling without hammering



Hammer drilling



Chiseling



Chisel position adjustment



Volts



Direct current

n_0

Rated speed under no load

/min

Revolutions per minute

RPM

Revolutions per minute

Ø

Diameter



Forward / reverse

Location of identification data on the power tool

The type designation can be found on the type identification plate and the serial number on the side of the motor housing. Make a note of this data in your operating instructions and always refer to it when making an enquiry to your Hilti representative or service department.

Type:

Serial no.:

2 Description

2.1 Use of the product as directed

The power tool is a cordless rotary hammer with pneumatic hammering mechanism.

The power tool is intended for drilling in concrete, masonry, metal and wood. The power tool can also be used for light chiseling work on masonry and surface finishing on concrete.

Working on materials hazardous to the health (e.g. asbestos) is not permissible.

The power tool is designed for professional use and may be operated, serviced and maintained only by trained, authorized personnel. This personnel must be informed of any special hazards that may be encountered. The power tool and its ancillary equipment may present hazards when used incorrectly by untrained personnel or when used not as directed.

The working environment may be as follows: construction site, workshop, renovation, conversion or new construction. Modification of the power tool or tampering with its parts is not permissible.

Do not use the battery as a power source for other unspecified appliances.

To avoid the risk of injury, use only genuine Hilti accessories and insert tools.

Observe the information printed in the operating instructions concerning operation, care and maintenance.

2.2 Chuck

TE-C CLICK chuck

2.3 Switches

Speed control switch for smooth starting

Function selector switch

Forward / reverse switch

2.4 Grips

Vibration-absorbing, pivotable side handle with depth gauge
Vibration-absorbing grip

2.5 Protective features

Mechanical slip clutch
Electronic overload protection

2.6 Additional electronic features of the power tool

The power tool is equipped with electronic overload protection. The power tool switches off automatically in the event of overloading. When the control switch is released and then pressed again, the power tool immediately regains full power.

In addition, the temperature of the power tool's electronics is monitored to ensure extra-long life. Spindle speed is reduced automatically by the electronic control unit in the event of the maximum permissible temperature being exceeded. The drive spindle then rotates only very slowly even when the control switch is fully depressed. The electronic control unit allows full spindle speed to be reached again as soon as the temperature has dropped to within the permissible range.

2.7 Lubrication

Oil lubrication

2.8 Items supplied as standard

- 1 Power tool
- 1 TE-C CLICK chuck
- 1 Side handle with depth gauge
- 1 Operating instructions
- 1 Hilti toolbox or cardboard box
- 1 Cleaning cloth
- 1 Grease

2.9 Additional items required for operating the tool

One B 36/2.4 NiCd battery with C 7/36-ACS charger or one B 36/3.3 Li-Ion battery with C4/36-90 or C4/36-350 charger, or one B 36/3.9 Li-Ion battery with C 4/36-ACS charger.

2.10 Li-ion battery charge status

LEDs light constantly	LEDs blink	Charge status C
LED 1,2,3,4	-	$C \geq 75 \%$
LED 1,2,3	-	$50 \% \leq C < 75 \%$
LED 1,2	-	$25 \% \leq C < 50 \%$
LED 1	-	$10 \% \leq C < 25 \%$
-	LED 1	$C < 10 \%$

NOTE

Indication of the charge status is not possible while the power tool is in operation or immediately after operation. Indication is given (LED 1 blinks) only when the battery is fully discharged or when it is too hot (temperature above 80°C).

3 Insert tools, accessories

Insert tools and accessories for the TE 7-A

Designation	Description
Hammer drill bits	∅ 5...28 mm (3/16" to 1")
Forming and installation drill bits	∅ 5...20 mm (3/16" to 3/4")
Lightweight percussion core bits	∅ 25...68 mm (1" to 2 1/2")
Multipurpose hole saws	∅ 25...82 mm (1" to 3 1/4"), hexagonal
Pointed chisels	C-type connection end
Flat chisel	C-type connection end
Shaped chisels	C-type connection end
Anchor-setting tools	C-type connection end
Quick-release chuck for wood and metal drill bits	With smooth shank, hexagonal shank
Keyed chuck	With smooth shank, hexagonal shank
Wood drill bits	∅ 3...20 mm (1/8" to 3/4")
Metal drill bits	∅ 3...13 mm (max. 1/2")
Metal drill bits / stepped drill bits	∅ 5...22 mm (3/16" to 7/8")

Designation	Short designation	Item number, description
Chuck	TE-C Click	273118
Charger	C7/36-ACS	
Charger for Li-ion batteries	C4/36-ACS	
Charger for Li-ion batteries	C 4/36-90	
Charger for Li-ion batteries	C 4/36-350	
Battery	B36/2.4 NiCd	228195
Battery		B36/3.3 Li-ion
Battery		B36/3.9 Li-ion
Dust module		TE DRS-M
Belt adapter (for B36/2.4 NiCd battery only)		BAP 36
Angular chuck		C-type connection end

4 Technical data

Right of technical changes reserved.

Power tool	TE 7-A
Rated voltage (DC voltage)	36 V
Weight	4.9 kg (10.8 lb)
Dimensions (L x W x H) for Li-Ion	401 mm (15.79") x 111 mm (4.37") x 217 mm (8.54")
Dimensions (L x W x H) with NiCd and belt adapter	387 mm (15.24") x 107 mm (4.21") x 217 mm (8.54")
Drilling speed without hammering	0...800/min
Hammer drilling speed	740/min
Single impact energy	2.6 J

Other information about the power tool

Chuck	TE-C Click
-------	------------

Battery	B 36/2.4 NiCd	B 36/3.3 Li-Ion	B 36/3.9 Li-Ion
Rated voltage	36 V	36 V	36 V
Capacity	2.4 Ah	3.3 Ah	3.9 Ah
Energy capacity	86.4 Wh	118.8 Wh	140.4 Wh
Weight	2.1 kg (4.63 lb)	1.65 kg (3.64 lb)	1.65 kg (3.64 lb)
Type of cell	NiCd	Li-ion	Li-ion
Number of cells	30	30	30
Recommended working temperature range	-20... +80°C (-4... +176 °F)	-20... +80°C (-4... +176 °F)	-20... +80°C (-4... +176 °F)

en

5 Safety instructions

NOTE

The safety rules in section 5.1 contain all general safety rules for power tools which, in accordance with the applicable standards, require to be listed in the operating instructions. Accordingly, some of the rules listed may not be relevant to this tool.

5.1 General power tool safety warnings

- a)  **WARNING**
Read all safety warnings and instructions. Failure to follow the warnings and instructions may result in electric shock, fire and/or serious injury. **Save all warnings and instructions for future reference.** The term “power tool” in the warnings refers to your mains-operated (corded) power tool or battery-operated (cordless) power tool.

5.1.1 Work area safety

- a) **Keep work area clean and well lit.** Cluttered or dark areas invite accidents.
- b) **Do not operate power tools in explosive atmospheres, such as in the presence of flammable liquids, gases or dust.** Power tools create sparks which may ignite the dust or fumes.
- c) **Keep children and bystanders away while operating a power tool.** Distractions can cause you to lose control.

5.1.2 Electrical safety

- a) **Power tool plugs must match the outlet. Never modify the plug in any way. Do not use any adapter plugs with earthed (grounded) power tools.** Unmodified plugs and matching outlets will reduce risk of electric shock.
- b) **Avoid body contact with earthed or grounded surfaces such as pipes, radiators, ranges and refrigerators.** There is an increased risk of electric shock if your body is earthed or grounded.

- c) **Do not expose power tools to rain or wet conditions.** Water entering a power tool will increase the risk of electric shock.
- d) **Do not abuse the cord. Never use the cord for carrying, pulling or unplugging the power tool. Keep cord away from heat, oil, sharp edges or moving parts.** Damaged or entangled cords increase the risk of electric shock.
- e) **When operating a power tool outdoors, use an extension cord suitable for outdoor use.** Use of a cord suitable for outdoor use reduces the risk of electric shock.
- f) **If operating a power tool in a damp location is unavoidable, use a residual current device (RCD) protected supply.** Use of an RCD reduces the risk of electric shock.

5.1.3 Personal safety

- a) **Stay alert, watch what you are doing and use common sense when operating a power tool. Do not use a power tool while you are tired or under the influence of drugs, alcohol or medication.** A moment of inattention while operating power tools may result in serious personal injury.
- b) **Use personal protective equipment. Always wear eye protection.** Protective equipment such as dust mask, non-skid safety shoes, hard hat, or hearing protection used for appropriate conditions will reduce personal injuries.
- c) **Prevent unintentional starting. Ensure the switch is in the off-position before connecting to power source and/or battery pack, picking up or carrying the tool.** Carrying power tools with your finger on the switch or energising power tools that have the switch on invites accidents.
- d) **Remove any adjusting key or wrench before turning the power tool on.** A wrench or a key left attached to a rotating part of the power tool may result in personal injury.

- e) **Do not overreach. Keep proper footing and balance at all times.** This enables better control of the power tool in unexpected situations.
- f) **Dress properly. Do not wear loose clothing or jewellery. Keep your hair, clothing and gloves away from moving parts.** Loose clothes, jewellery or long hair can be caught in moving parts.
- g) **If devices are provided for the connection of dust extraction and collection facilities, ensure these are connected and properly used.** Use of dust collection can reduce dust-related hazards.

5.1.4 Power tool use and care

- a) **Do not force the power tool. Use the correct power tool for your application.** The correct power tool will do the job better and safer at the rate for which it was designed.
- b) **Do not use the power tool if the switch does not turn it on and off.** Any power tool that cannot be controlled with the switch is dangerous and must be repaired.
- c) **Disconnect the plug from the power source and/or the battery pack from the power tool before making any adjustments, changing accessories, or storing power tools.** Such preventive safety measures reduce the risk of starting the power tool accidentally.
- d) **Store idle power tools out of the reach of children and do not allow persons unfamiliar with the power tool or these instructions to operate the power tool.** Power tools are dangerous in the hands of untrained users.
- e) **Maintain power tools. Check for misalignment or binding of moving parts, breakage of parts and any other condition that may affect the power tool's operation. If damaged, have the power tool repaired before use.** Many accidents are caused by poorly maintained power tools.
- f) **Keep cutting tools sharp and clean.** Properly maintained cutting tools with sharp cutting edges are less likely to bind and are easier to control.
- g) **Use the power tool, accessories and tool bits etc. in accordance with these instructions taking into account the working conditions and the work to be performed.** Use of the power tool for operations different from those intended could result in a hazardous situation.

5.1.5 Battery tool use and care

- a) **Recharge only with the charger specified by the manufacturer.** A charger that is suitable for one type of battery pack may create a risk of fire when used with another battery pack.
- b) **Use power tools only with specifically designated battery packs.** Use of any other battery packs may create a risk of injury and fire.
- c) **When battery pack is not in use, keep it away from other metal objects, like paper clips, coins, keys, nails, screws or other small metal objects, that can make a connection from one terminal to another.** Shorting the battery terminals together may cause burns or a fire.

- d) **Under abusive conditions, liquid may be ejected from the battery, avoid contact. If contact accidentally occurs, flush with water. If liquid contacts eyes, additionally seek medical help.** Liquid ejected from the battery may cause irritation or burns.

5.1.6 Service

- a) **Have your power tool serviced by a qualified repair person using only identical replacement parts.** This will ensure that the safety of the power tool is maintained.

5.2 Hammer safety warnings

- a) **Wear ear protectors.** Exposure to noise can cause hearing loss.
- b) **Use auxiliary handles, if supplied with the tool.** Loss of control can cause personal injury.
- c) **Hold power tool by insulated gripping surfaces, when performing an operation where the cutting accessory may contact hidden wiring.** Cutting accessory contacting a "live" wire may make exposed metal parts of the power tool "live" and could give the operator an electric shock.

5.3 Additional safety precautions

5.3.1 Personal safety

- a) **Keep the grips dry, clean and free from oil and grease.**
- b) **Breathing protection must be worn if the power tool is used without a dust removal system for work that creates dust.**
- c) **Improve the blood circulation in your fingers by relaxing your hands and exercising your fingers during breaks between working.**
- d) **Avoid touching rotating parts. Switch the power tool on only after bringing it into position at the workpiece.** Touching rotating parts, especially rotating insert tools, may lead to injury.
- e) **Activate the safety lock (forward / reverse switch in the middle position) before storing or transporting the power tool.**
- f) **When restarting after the electronic overload protection system has switched the tool off, care must be taken to ensure that the power tool is held securely with both hands on the grips provided.**
- g) **Children must be instructed not to play with the power tool.**
- h) **The power tool is not intended for use by children, by debilitated persons or those who have received no instruction or training.**

5.3.2 Power tool use and care

- a) **Secure the workpiece. Use clamps or a vice to secure the workpiece.** The workpiece is thus held more securely than by hand and both hands remain free to operate the power tool.
- b) **Check that the insert tools used are compatible with the chuck system and that they are secured in the chuck correctly.**

5.3.3 Cordless tool use and care

- a) Observe the special instructions applicable to the transport, storage and use of Li-ion batteries.
- b) Do not expose batteries to high temperatures or fire. This presents a risk of explosion.
- c) Do not disassemble, squash or incinerate batteries and do not subject them to temperatures over 80°C. A risk of fire, explosion or injury through contact with caustic substances may otherwise result.
- d) Do not use batteries other than those approved for use with the applicable power tool or appliance. Use of other batteries or use of the battery for purposes for which it is not intended presents a risk of fire and explosion.
- e) Do not charge or continue to use damaged batteries (e.g. batteries with cracks, broken parts, bent or pushed-in and/or pulled-out contacts).
- f) If the battery gets too hot to touch, this may indicate that it is faulty. Place the tool in a location where it can be kept under observation, well away from flammable materials, and allow it to cool down. Contact Hilti Service after the battery has been allowed to cool.

5.3.4 Electrical safety



Before beginning work, check the working area (e.g. using a metal detector) to ensure that no concealed electric cables or gas and water pipes are present. External metal parts of the power tool may become live, for example, when an electric cable is damaged accidentally. This presents a serious risk of electric shock.

5.3.5 Work area safety

- a) Ensure that the workplace is well lit.
- b) Ensure that the workplace is well ventilated. Exposure to dust at a poorly ventilated workplace may result in damage to the health.
- c) **WARNING:** Some dust created by grinding, sanding, cutting and drilling contains chemicals known

to cause cancer, birth defects, infertility or other reproductive harm; or serious and permanent respiratory or other injury. Some examples of these chemicals are: lead from lead-based paints, crystalline silica from bricks, concrete and other masonry products and natural stone, arsenic and chromium from chemically-treated lumber. Your risk from these exposures varies, depending on how often you do this type of work. To reduce exposure to these chemicals, the operator and bystanders should work in a well-ventilated area, work with approved safety equipment, such as respiratory protection appropriate for the type of dust generated, and designed to filter out microscopic particles and direct dust away from the face and body. Avoid prolonged contact with dust. Wear protective clothing and wash exposed areas with soap and water. Allowing dust to get into your mouth, eyes, or to remain on your skin may promote absorption of harmful chemicals.

5.3.6 Personal protective equipment



The user and any other persons in the vicinity must wear suitable eye protection, a hard hat, ear protection, protective gloves and breathing protection while the tool is in use.

5.4 Safety in conjunction with the belt adaptor (accessory)

- a) Check that the belt adaptor is securely attached to the belt before beginning work.
- b) Take care to ensure that the cord hanging from the belt adaptor does not catch on anything. Disconnect the power tool from the belt adaptor before laying it down.

6 Before use



6.1 Battery use and care

NOTE
Battery performance drops at low temperatures. Never use the battery until the cells become fully discharged. Change to the second battery as soon as a drop in performance is noticed. Recharge the battery immediately so that it is ready for reuse.

Store the battery in a cool, dry place. Never store the battery where it is exposed to direct sunlight or sources of heat, e.g. on heaters / radiators or behind a motor vehicle windscreen. Batteries that have reached the end of their life must be disposed of safely and correctly to avoid environmental pollution.

6.2 Charging the battery



en

CAUTION

Use only the Hilti chargers listed under "Accessories".

DANGER

Ensure that the outer surfaces of the battery are clean and dry before inserting it in the corresponding charger. Read the operating instructions for the charger for further information about the charging procedure.

6.2.1 Charging a new battery for the first time

A new battery must be charged correctly for the first time before use. This will ensure that the cells form correctly. Incorrect initial charging may have a permanent, negative effect on battery capacity. Please refer to the applicable battery charger's operating instructions for information about initial charging.

6.2.2 Recharging NiCd batteries

NiCd batteries should be allowed to reach full charge each time they are charged.

6.2.3 Recharging Li-ion batteries

Li-ion batteries are ready for use at any time, even when only partly charged. Charging progress is indicated by the LED display (see charger operating instructions).

6.3 Fitting the battery 2

CAUTION

Before fitting the battery, check that the tool is switched off and that the transport lock is engaged (forward/reverse switch in the middle position). Use only the Hilti batteries approved for use with this power tool.

1. Push the battery into the power tool from the rear until it is heard to engage with a double click.
2. **CAUTION** A falling battery may present a risk of injury to yourself or others.
Check that the battery is seated securely in the power tool.

6.4 Removing the battery 3

1. Press both battery release buttons.
2. Pull the battery out of the power tool toward the rear.

6.5 Transport and storage of battery packs

Pull the battery pack out of the locked position (working position) and move it into the first click-stop position (transport position).

If you disconnect a battery pack from the power tool for transport or storage, make sure that the contacts of the battery pack are not short-circuited. Remove loose metal parts such as screws, nails, clamps, loose screw bits, wires or metal swarf from the case, toolbox or transport container, or prevent these parts from coming into contact with the battery packs.

Observe national and international transport regulations when shipping battery packs (transportation by road, rail, sea or air).

6.6 Fitting the side handle 4

CAUTION

Remove the depth gauge from the side handle in order to avoid injury.

1. Set the forward / reverse switch to the middle position or remove the battery from the power tool.
2. Release the side handle clamping band by turning the handle counterclockwise.
3. Slide the side handle clamping band over the chuck and onto the cylindrical section at the front end of the power tool.
4. Pivot the side handle into the desired position.
5. Secure the side handle by turning the grip clockwise.

6.7 Use of the belt adapter

NOTE

The working weight of the power tool can be reduced by fitting an accessory belt adapter. The battery cannot be charged by way of the belt adapter.

NOTE

The belt adapter cannot be used in conjunction with Li-ion batteries.

Observe the instructions given in the section "Safety rules" on safe use of the belt adapter.

7 Operation



CAUTION

In the event of the drill bit sticking, the power tool will pivot about its own axis. Always use the power tool with the side handle fitted and hold it securely with both hands

so that the resulting opposing force causes the slip clutch to release in the event of the drill bit sticking. Use clamps or a vice to hold the workpiece securely.

7.1 Preparing for use

7.1.1 Fitting the insert tool 5

CAUTION

Wear protective gloves when changing the insert tool.

1. Set the forward / reverse switch to the middle position or remove the battery from the power tool.
2. Check that the connection end of the insert tool is clean and lightly greased. Clean it and grease it if necessary.
3. Check that the sealing lip of the dust shield is clean and in good condition. Clean the dust shield if necessary or replace it if the sealing lip is found to be damaged (please refer to the “Care and maintenance” section).
4. Push the insert tool into the chuck and rotate it while applying slight pressure until it engages in the guide grooves.
5. Push the insert tool further into the chuck until it is heard to engage.
6. Check that the insert tool has engaged correctly by pulling it.

7.1.2 Adjusting the depth gauge 6

1. Release the side handle clamping band by turning the handle counterclockwise.
2. Pivot the side handle into the desired position.
3. Adjust the depth gauge to the desired drilling depth.
4. Tighten the side handle securely by turning the grip section. This also clamps the depth gauge in position.

7.1.3 Removing the insert tool 7

CAUTION

Wear protective gloves when changing insert tools as the insert tool will get hot during use.

1. Set the forward / reverse switch to the middle position or remove the battery from the power tool.
2. Open the chuck by pulling back the chuck release sleeve.
3. Pull the insert tool out of the chuck.

7.1.4 Removing the chuck 8

CAUTION

Remove the depth gauge from the side handle and the insert tool from the chuck in order to avoid injury.

NOTE

Set the selector switch to the “Chiseling” position before removing the chuck.

1. Set the forward / reverse switch to the middle position or remove the battery from the power tool.
2. Pull the chuck sleeve forward and hold it securely.
3. Remove the chuck by pulling it away from the power tool.

7.1.5 Fitting the chuck 9

CAUTION

Remove the depth gauge from the side handle and the insert tool from the chuck in order to avoid injury.

NOTE

Set the selector switch to the “Chiseling” position before removing the chuck.

1. Set the forward / reverse switch to the middle position or remove the battery from the power tool.
2. Grip the chuck sleeve, pull it forward and hold it securely in this position.
3. Slide the chuck onto the guide tube from the front and then release the sleeve.
4. Rotate the chuck until it is heard to engage.

7.2 Operation



CAUTION

Working on the material may cause it to splinter. **Wear eye protection and protective gloves. Wear breathing protection if no dust removal system is used.** Splintering material presents a risk of injury to the eyes and body.

CAUTION

The work generates noise. **Wear ear protectors.** Exposure to noise can cause hearing loss.

7.2.1 Working at low temperatures

NOTE

The hammering mechanism works only when the power tool has reached a minimum operating temperature.

Bring the drill bit briefly into contact with the base material while allowing the power tool to run under no load until the minimum operating temperature is reached. If necessary, repeat this procedure until the hammering mechanism begins to operate.

7.2.2 Drilling without hammering 10

1. Turn the function selector switch until it engages in the “Drilling without hammering” position. Do not operate the function selector switch while the motor is running.
2. Bring the side handle into the desired position and check that it is fitted correctly and secured.
3. Fit the battery.
4. Position the power tool and drill bit at the point where the hole is to be drilled.
5. Press the control switch slowly (drill at a low speed until the drill bit centers itself in the hole).
6. Press the control switch fully to continue drilling with full power.
7. Adjust the pressure applied to the power tool according to the material you are working on. This will ensure the optimum rate of drilling progress.

7.2.3 Hammer drilling 11

1. Turn the function selector switch until it engages in the “Hammer drilling” position. Do not operate the function selector switch while the motor is running.
2. Bring the side handle into the desired position and check that it is fitted correctly and secured.

3. Fit the battery.
4. Position the power tool and drill bit at the point where the hole is to be drilled.
5. Press the control switch slowly (drill at a low speed until the drill bit centers itself in the hole).
6. Press the control switch fully to continue drilling with full power.
7. Adjust the pressure applied to the power tool according to the material you are working on. This will ensure the optimum rate of drilling progress.
8. Reduce drilling speed shortly before breaking through in order to avoid spalling.

7.2.4 Chiseling

NOTE

The chisel can be adjusted to 18 different positions. This ensures that flat chisels and shaped chisels can always be set to the optimum working position.

NOTE

Check that the connection end of the insert tool is clean and lightly greased. Clean it and grease it if necessary.

7.2.4.1 Chisel position adjustment

CAUTION

Do not operate the power tool when the selector switch is set to "Chisel adjustment".

1. Turn the function selector switch until it engages in the "Chisel adjustment" position. Do not operate the function selector switch while the motor is running.
2. Bring the side handle into the desired position and check that it is fitted correctly and secured.
3. Rotate the chisel to the desired position.

7.2.4.2 Locking the chisel

Turn the function selector switch until it engages in the "Chiseling" position. Do not operate the function selector switch while the motor is running.

7.2.4.3 Chiseling

1. Fit the battery.
NOTE Do not operate the function selector switch while the motor is running.
2. Position the tip of the chisel at the point where chiseling is to begin.
3. Press the control switch.

7.2.5 Forward / reverse

NOTE

The forward / reverse switch is used to select the direction of rotation of the drive spindle. An interlock prevents switching while the motor is running. The control switch is locked when the forward / reverse switch is in the middle position.

For forward rotation, push the forward / reverse switch on the side of the power tool toward the chuck in the direction of the arrow.

For reverse rotation, push the forward / reverse switch on the side of the power tool toward the grip in the direction of the arrow.

Bring the forward / reverse switch into the desired position.

7.2.6 Reading the charge status LED display on Li-ion batteries

NOTE

Indication of the charge status is not possible while the power tool is in operation or immediately after operation. Indication is given (LED 1 blinks) only when the battery is fully discharged or when it is too hot (temperature >80°).

The Li-ion battery features a charge status LED display. During charging, charge status is indicated by the display on the battery. This information is not available for 3-4 seconds after using the power tool. When the battery is at rest (not in use), its charge status is indicated by the four LEDs on the battery for a time of three seconds after pressing one of the battery release buttons.

See section: 2.10 Li-ion battery charge status

8 Care and maintenance

CAUTION

Before beginning cleaning, remove the battery from the power tool in order to prevent unintentional starting.

8.1 Care of insert tools

Clean off dirt and dust deposits adhering to the insert tools and protect them from corrosion by wiping the insert tools from time to time with an oil-soaked rag. Check that the connection end of the insert tool is clean and lightly greased. Clean it and grease it if necessary.

8.2 Care of the power tool

CAUTION

Keep the power tool, especially its grip surfaces, clean and free from oil and grease. Do not use cleaning agents which contain silicone.

The outer casing of the power tool is made from impact-resistant plastic. Sections of the grip are made from a synthetic rubber material.

Never operate the power tool when the ventilation slots are blocked. Clean the ventilation slots carefully using

a dry brush. Do not permit foreign objects to enter the interior of the power tool. Clean the outside of the power tool at regular intervals with a slightly damp cloth. Do not use a spray, steam pressure cleaning equipment or running water for cleaning. This may negatively affect the electrical safety of the power tool.

8.3 Cleaning or replacing the dust shield

Clean the dust shield on the chuck with a dry, clean cloth at regular intervals. Clean the sealing lip by wiping it carefully and then grease it again lightly with Hilti grease. It is essential that the dust shield is replaced if the sealing lip is found to be damaged. Push the tip of a screwdriver under the edge of the dust shield and prise it out toward the front. Clean the area of the chuck in contact with dust shield and then fit a new dust shield. Press it in firmly until it engages.

8.4 Care of the NiCd battery

Avoid entrance of moisture. Keep the electrical contacts free from dust, oil and grease. If necessary, use a clean cloth to clean the contact surfaces. Do not continue to operate the power tool until the battery is completely discharged as this may damage the battery cells. Recharge the battery as soon as a drop in performance is noticed.

NOTE

Please refer to the operating instructions for the charger for further information about charging the battery.

8.5 Care of the Li-ion battery

Avoid entrance of moisture. Charge the battery fully before using it for the first time. In order to achieve maximum battery life, stop discharging the battery as soon as a significant drop in performance is noticed.

NOTE

If use of the power tool continues, further battery discharge will be stopped automatically before the battery cells suffer damage.

Charge the battery with the Hilti charger approved for use with Li-ion batteries.

NOTE

- A conditioning charge (as is required with NiCd or NiMH batteries) is not necessary.
- Interruption of the charging procedure has no negative effect on battery life.
- Charging can be started at any time with no negative effect on battery life. There is no memory effect (as with NiCd or NiMH batteries).
- For best results, batteries should be stored fully charged in a cool dry place. Avoid charging the battery in places subject to high ambient temperatures (e.g. at a window) as this has an adverse effect on battery life and increases the rate of self-discharge.
- If the battery no longer reaches full charge, it may have lost capacity due to aging or overstraining. It is possible to continue working with a battery in this condition but it should be replaced in good time.

8.6 Maintenance

WARNING

Repairs to the electrical section of the power tool may be carried out only by trained electrical specialists.

Check all external parts of the power tool for damage at regular intervals and check that all controls operate faultlessly. Do not operate the power tool if parts are damaged or when the controls do not function faultlessly. If necessary, the power tool should be repaired by Hilti Service.

8.7 Checking the power tool after care and maintenance

After carrying out care and maintenance work on the power tool, check that all protective and safety devices are fitted and that they function faultlessly.

9 Troubleshooting

Fault	Possible cause	Remedy
The power tool doesn't run.	The battery is discharged or fitted incorrectly.	The battery must be heard to engage with a double click or, respectively, needs to be charged.
	Electrical fault.	Remove the battery from the power tool and contact Hilti Service.
	The battery is too hot or too cold.	Bring the battery to the recommended working temperature.
No hammering action.	The power tool is too cold.	Allow the power tool to warm up to the minimum operating temperature. See section: 7.2.1 Working at low temperatures

Fault	Possible cause	Remedy
No hammering action.	The function selector switch is set to "Drilling without hammering".	Set the function selector switch to "Hammer drilling".
	The forward/reverse switch is set to reverse rotation.	Set the forward/reverse switch to forward rotation.
The control switch can't be pressed, i.e. the switch is locked.	The forward / reverse switch is in the middle position (transport lock engaged).	Push the forward / reverse switch to the left or right.
Running speed suddenly drops considerably.	The battery is discharged.	Change the battery and recharge the discharged battery.
The drive spindle rotates only slowly.	The permissible operating temperature of the power tool's electronics has been exceeded.	Allow the power tool to cool down.
The power tool switches itself off automatically.	The overload cut-out has been activated.	Release the control switch, reduce the load on the power tool and then press the switch again.
The battery runs down more quickly than usual.	Battery condition is not optimal.	Have battery condition diagnosed by Hilti Service or replace with a new battery.
The battery doesn't engage with an audible double click.	The retaining lugs on the battery are dirty.	Clean the retaining lugs and check that the battery engages securely. Contact Hilti Service if the problem persists.
The power tool or the battery gets very warm.	Electrical fault.	Switch the power tool off immediately, remove the battery and contact Hilti Service.
	The power tool has been overloaded (application limits exceeded).	Use the right power tool for the job (don't use a low-powered tool for heavy work).
The drill bit doesn't rotate.	The function selector switch is not engaged or is set to "Chiseling" or "Chisel adjustment".	When the motor has stopped, move the function control switch to the "Drilling without hammering" or "Hammer drilling" position.
The insert tool can't be released.	The chuck is not pulled back fully.	Pull the chuck back as far as it will go and remove the cutting tool.
The tool makes no progress.	The forward/reverse switch is set to reverse rotation.	Set the forward/reverse switch to forward rotation.

10 Disposal

CAUTION

Improper disposal of the equipment may have serious consequences: the burning of plastic components generates toxic fumes which may present a health hazard. Batteries may explode if damaged or exposed to very high temperatures, causing poisoning, burns, acid burns or environmental pollution. Careless disposal may permit unauthorized and improper use of the equipment. This may result in serious personal injury, injury to third parties and pollution of the environment.

CAUTION

Dispose of defective batteries without delay. Keep them out of reach of children. Do not attempt to open or dismantle batteries and do not dispose of them by incineration.

CAUTION

Dispose of the batteries in accordance with national regulations or return them to Hilti.



Most of the materials from which Hilti power tools or appliances are manufactured can be recycled. The materials must be correctly separated before they can be recycled. In many countries, Hilti has already made arrangements for taking back your old power tools or appliances for recycling. Please ask your Hilti customer service department or Hilti representative for further information.

11 Manufacturer's warranty - tools

Hilti warrants that the tool supplied is free of defects in material and workmanship. This warranty is valid so long as the tool is operated and handled correctly, cleaned and serviced properly and in accordance with the Hilti Operating Instructions, and the technical system is maintained. This means that only original Hilti consumables, components and spare parts may be used in the tool.

This warranty provides the free-of-charge repair or replacement of defective parts only over the entire lifespan of the tool. Parts requiring repair or replacement as a result of normal wear and tear are not covered by this warranty.

Additional claims are excluded, unless stringent national rules prohibit such exclusion. In particular, Hilti is not obligated for direct, indirect, incidental or consequential damages, losses or expenses in connection with, or by reason of, the use of, or inability to use the tool for any purpose. Implied warranties of merchantability or fitness for a particular purpose are specifically excluded.

For repair or replacement, send the tool or related parts immediately upon discovery of the defect to the address of the local Hilti marketing organization provided.

This constitutes Hilti's entire obligation with regard to warranty and supersedes all prior or contemporaneous comments and oral or written agreements concerning warranties.



Hilti Corporation

LI-9494 Schaan

Tel.: +423 / 234 21 11

Fax: +423 / 234 29 65

www.hilti.com

Hilti = registered trademark of Hilti Corp., Schaan

W 3091 | 0613 | 10-Pos. 3 | 1

Printed in Liechtenstein © 2013

Right of technical and programme changes reserved S. E. & O.

202926 / A2



202926