

	SBT 4-A22 SF BT 18/22-A
	TS-BT 5.5-74 S
	SBT 4-A22 SFC 18/22-A
	S-DG BT M8/15 Long 6 S-DG BT M6-W6/15 Long 6
	S-CC BT 6

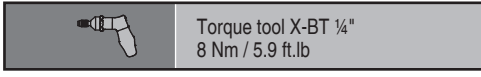

	S-NS 10 C 95/3 1/4" (M6)
	S-NS 5/6 C 95/3 1/4" (W6)
	S-NS 13 C 95/3 1/4" (M8)

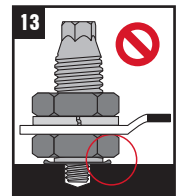

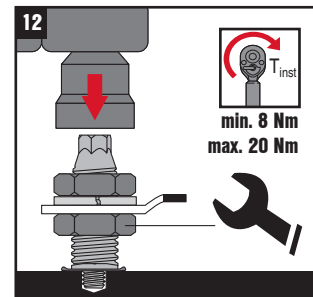
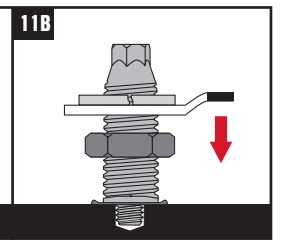
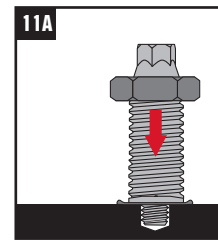
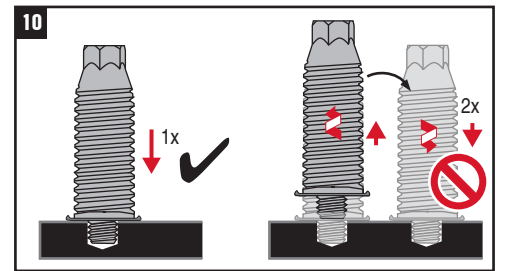
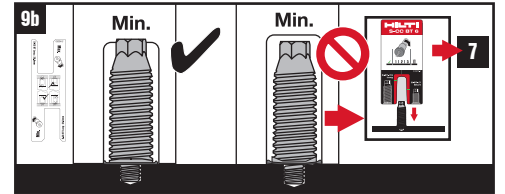
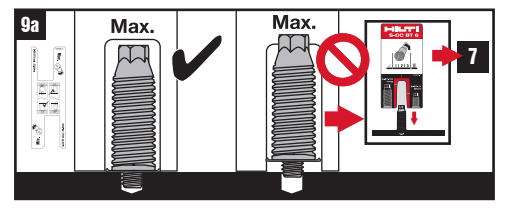
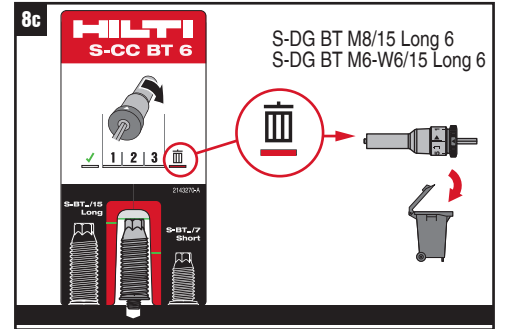
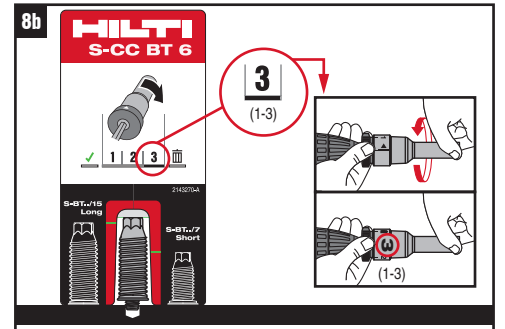
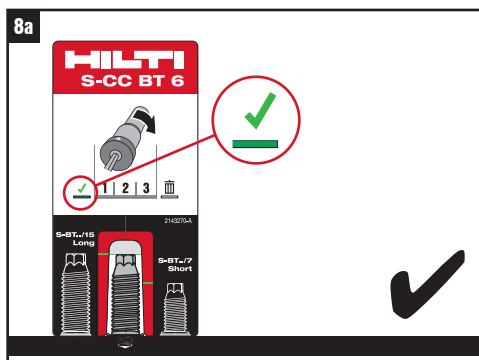
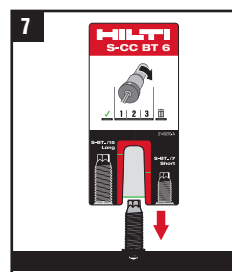
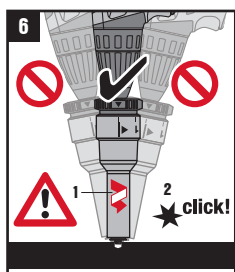
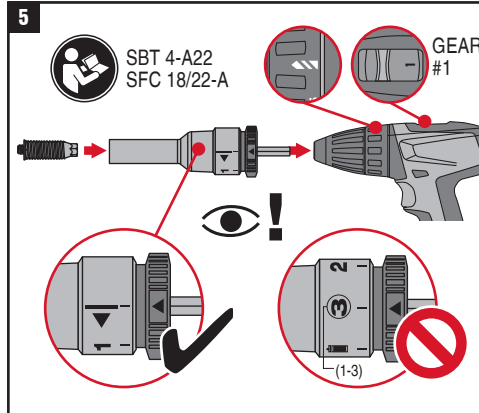
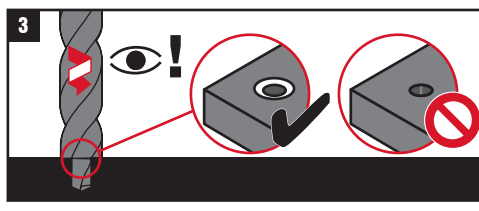
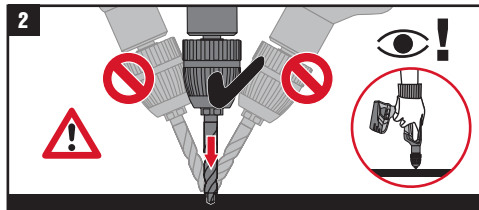
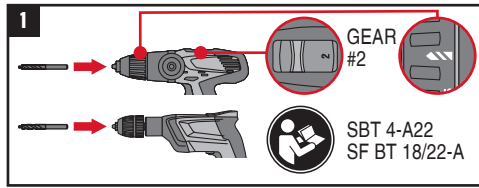
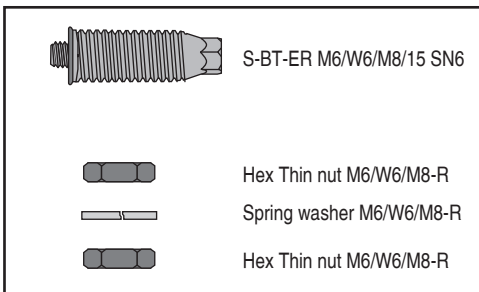
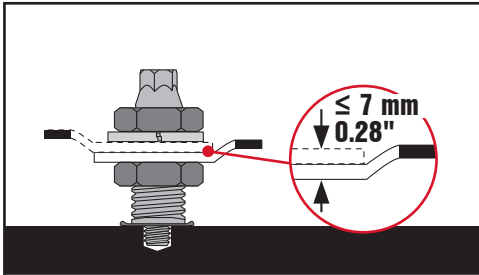
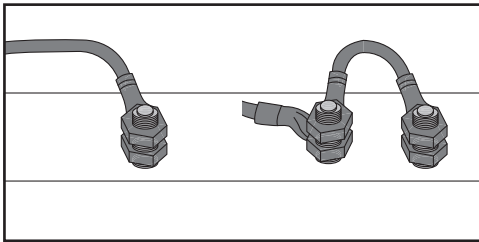
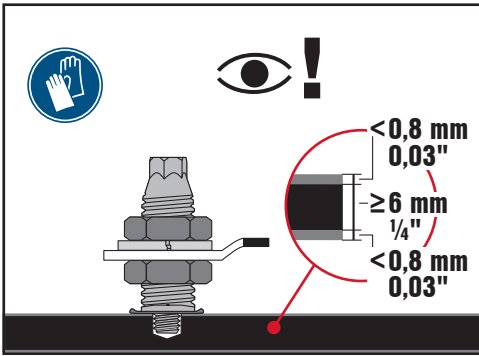

	SBT 4-A22
	TS-BT 5.5-74 S
	SBT 4-A22 SFC 18/22-A
	S-DG BT M8/15 Long 6 S-DG BT M6-W6/15 Long 6
	S-CC BT 6

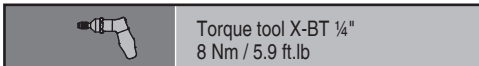

	S-NS 10 C 95/3 3/4" (M6)
	S-NS 5/6 C 95/3 3/4" (W6)
	S-NS 13 C 95/3 3/4" (M8)

